

# avenlur

## Neem by Avenlur



### Need Help?

CALL US AT 888.697.3931 / M-F 9AM - 5PM PT (12PM - 8PM ET)  
OR EMAIL US AT [INFO@AVENLUR.COM](mailto:INFO@AVENLUR.COM)

## **WARNING**

Adult assembly required.

## **WARNING**

Maximum user weight: 330 lbs (150kg) each.

## **WARNING**

### **CHOKING HAZARD:**

Adult assembly required. Keep small assembly parts out of reach of children.

 Use under adult supervision.

**OBSERVE ALL STATEMENTS AND WARNINGS TO REDUCE THE LIKELIHOOD OF SERIOUS OR FATAL INJURY. SAVE THIS SHEET FOR FUTURE REFERENCE.**

## **OPERATION INSTRUCTIONS**

1. An adult should always supervise use of this product by children of all ages.
2. Instruct children not to attach items to the playground equipment that are not specifically designed for use with the equipment (examples: ropes, clothesline, pet leashes, cables and chain, etc) as they may cause a strangulation hazard or any other hazard.
3. Never allow children to use the equipment in a manner other than intended.

## **MAINTENANCE INSTRUCTIONS**

1. Inspect the product periodically for loose or damaged components. **Tighten bolts if need.**
2. Check all connections and bolts for tightness at least twice monthly during the usage.
3. Check all coverings and bolts for sharp edges.

## **INSTALLATION INSTRUCTIONS**

Please have an electrical drill available for assembly if possible.  
If you have difficulty in installation, please contact us for help.

### **Please Ensure:**

1. You are assembling with at least two people to ensure that all sides and parts are leveled.
2. You don't screw the parts in too hard or it will splinter the wood.
3. You follow the directions carefully.

## **CONTACT US BEFORE ASSEMBLY**

If you have assembly questions or if you need parts  
whether they are missing or damaged

Call us at 888-697-3931 or email us at

[info@Avenlur.com](mailto:info@Avenlur.com)

## **ADVERTENCIA**

Se requiere Asamblea de adultos.

## **ADVERTENCIA**

Peso máximo del usuario: 150kg por niño.

## **ADVERTENCIA**

 Riesgo de asfixia:

Se requiere Asamblea de adultos. Mantenga las partes pequeñas del.

 Uso bajo supervisión de un adulto

**OBSERVAR TODAS LAS DECLARACIONES Y ADVERTENCIAS PARA REDUCIR LA PROBABILIDAD DE LESIONES GRAVES O MORTALES. GUARDE ESTA HOJA PARA FUTURAS REFERENCIAS.**

### **INSTRUCCIONES DE USO**

1. Un adulto siempre debe supervisar el uso de este producto por los niños de todas las edades.
2. Indique a los niños que no coloquen elementos en el equipo del patio de recreo que no estén específicamente diseñados para usarse con el equipo (ejemplos: cuerdas, tendedero, correas para mascotas, cables y cadenas, etc.) ya que pueden causar un peligro de estrangulación o cualquier otro peligro.
3. Nunca permita que los niños usen el equipo de una manera distinta a la prevista.

### **INSTRUCCIONES DE MANTENIMIENTO**

1. Inspeccione el producto periódicamente para detectar componentes sueltos o dañados. Apriete los pernos si es neces.
2. Compruebe la estanqueidad de todas las conexiones y pernos al menos dos veces al mes durante el uso.
3. Compruebe todos los cubrimientos y los pernos para los bordes agudos.

### **INSTRUCCIONES DE INSTALACIÓN**

Tenga un taladro eléctrico disponible para el montaje si es posible.

Si usted tiene dificultad en la instalación, por favor póngase en contacto con nosotros para obtener ayuda.

#### **Asegúrese de:**

1. Usted está ensamblando con al menos dos personas para asegurarse de que todos los lados y partes están nivelados.
2. Usted no atornille las piezas en demasiado duro o se astillará la madera.
3. Siga las instrucciones cuidadosamente.

## **CONTACTENOS ANTES DE ENSAMBLAR**

Si usted tiene preguntas de ensamblaje o necesita partes,  
le faltan piezas o están dañadas.

Lámenos al 888-697-3931 or escribanos a  
[info@avenlur.com](mailto:info@avenlur.com)

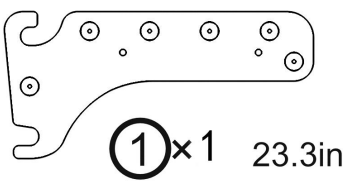

①×1 23.3in

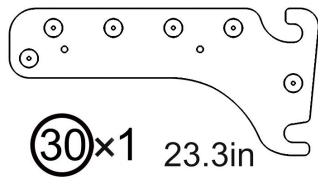

③⑩×1 23.3in

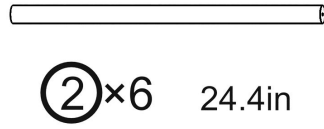

②×6 24.4in

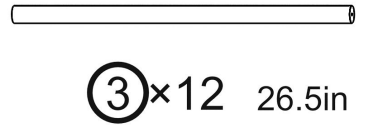

③×12 26.5in

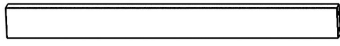

④×4 25.4in

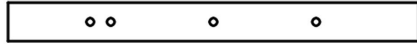

⑥×2 25.4in

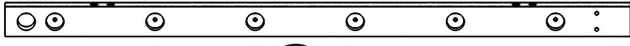

⑦×1 47.2in

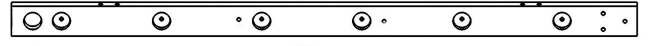

⑧×1 47.2in



⑨×1 47.2in



⑩×1 47.2in

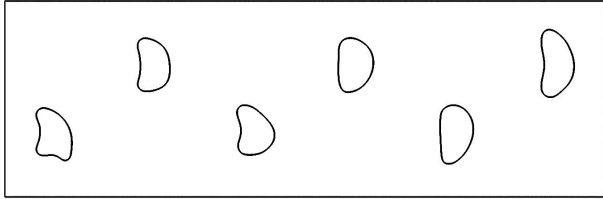

⑱×1 45.3in



⑫×1 47.2in

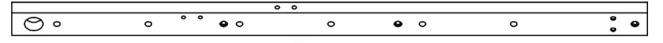

⑭×1 47.2in

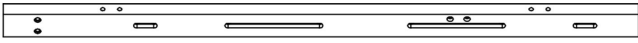

⑬×1 47.2in



⑮×1 47.2in



⑯×12 2.4in

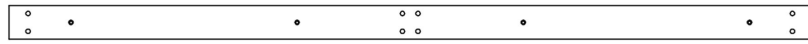

⑰×3 56.7in

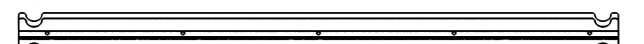

⑱×2 45.3in

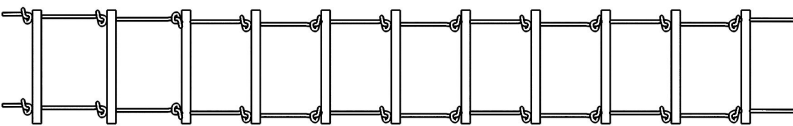

⑳×1

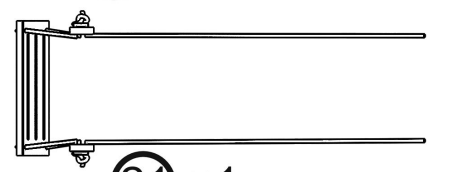

㉑×1

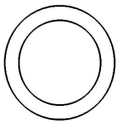

㉒×2



㉔×2 78.7in



㉕×2 216.5in



㉖×1 366.1in



M6.3×40  
A×70



M6×120 M6×20  
B×24

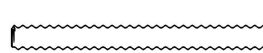

M8×100  
C×4

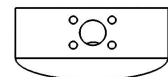

D×8



M8  
E×8

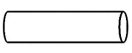

M10×40  
F×8

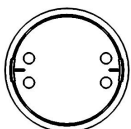

G×8



M6×80  
H×12



M4  
I×2



M8  
J×1



M6×40 M6×20  
K×6



# Self-provided tools



Pen



Drill

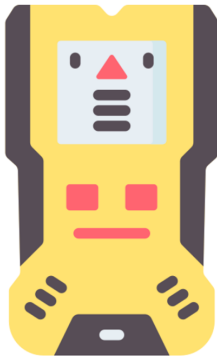

Studfinder



Measuring tape



Level

### 01-1

Note: Check all connections and bolts for tightness at least twice monthly during use. Do not use if screws are loose.

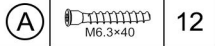
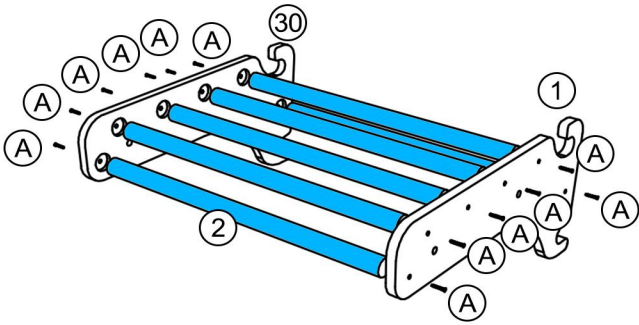

### 01-2

Note: Pay attention to all the black bubbled section markers. The manual may refer back to those later

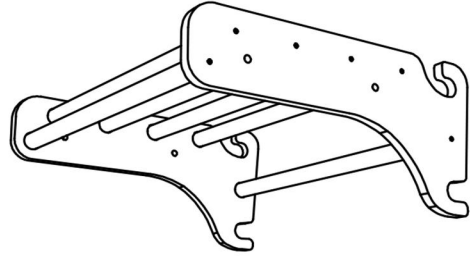

### 02-1

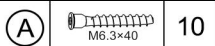
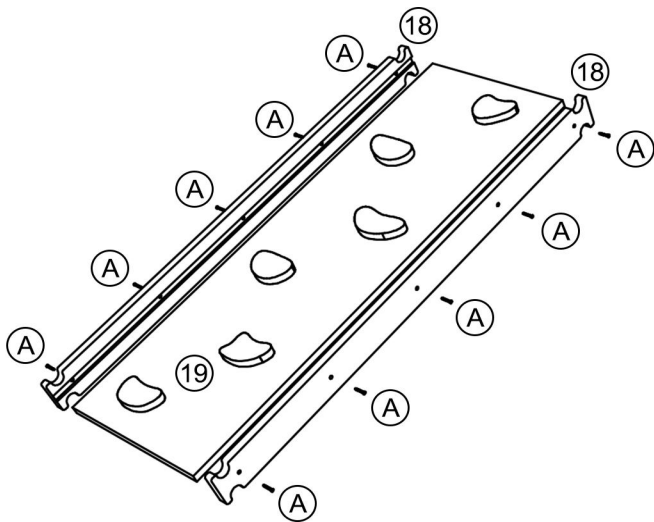

### 02-2

Note: Pay attention to all the black bubbled section markers. The manual may refer back to those later

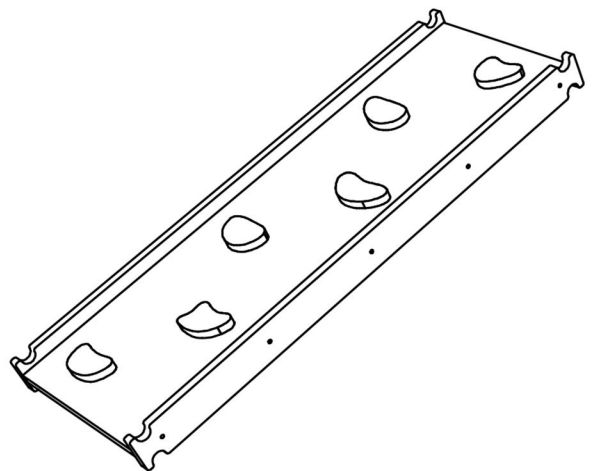

### 03-1

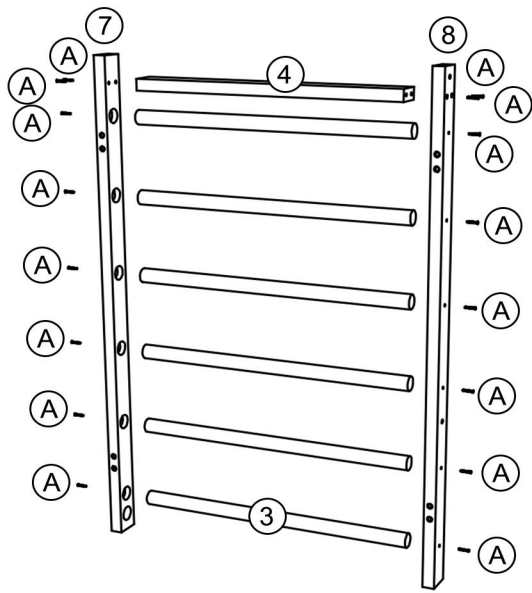

(A)  16

### 03-2

Note: Pay attention to all the black bubbled section markers. The manual may refer back to those later



### 04-1

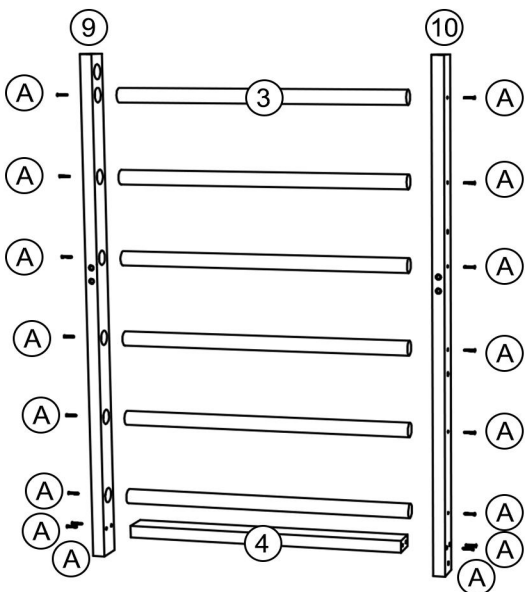

(A)  16

### 04-2

Note: Pay attention to all the black bubbled section markers. The manual may refer back to those later

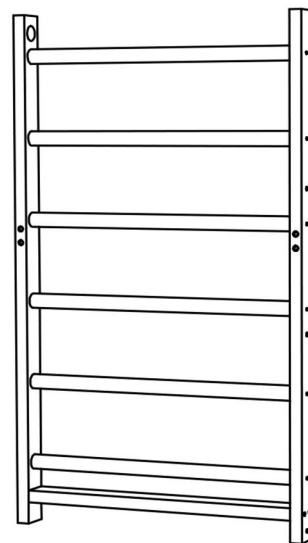

05-1

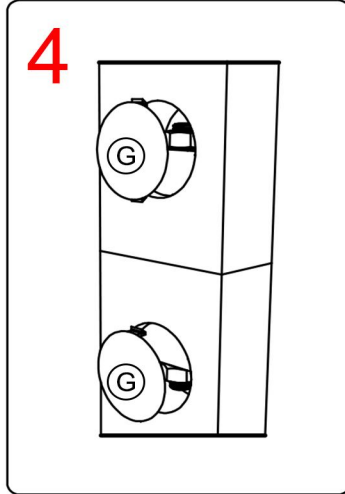
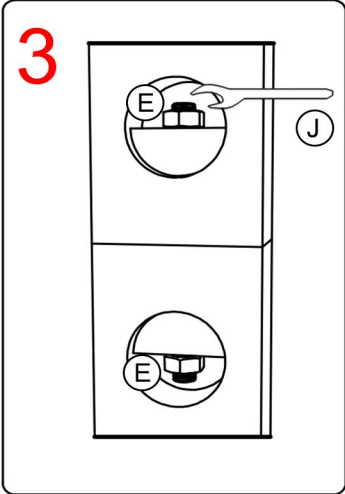
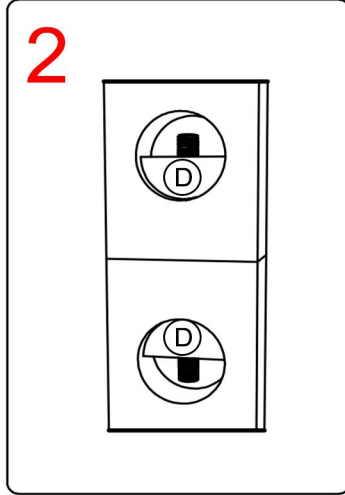
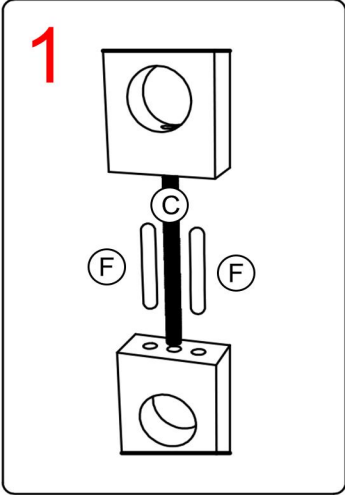
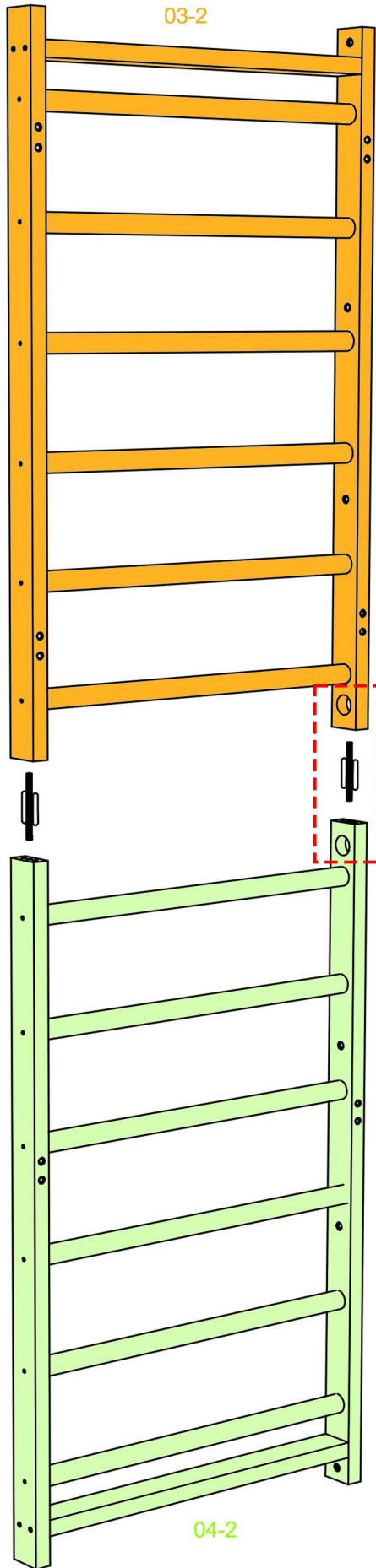

Note: Insert ① and ② into the holes. Attach ③, and tighten the connection by screwing on ④ to ①. Cover with ⑤

05-2



Note: Pay attention to all the black bubbled section markers. The manual may refer back to those later

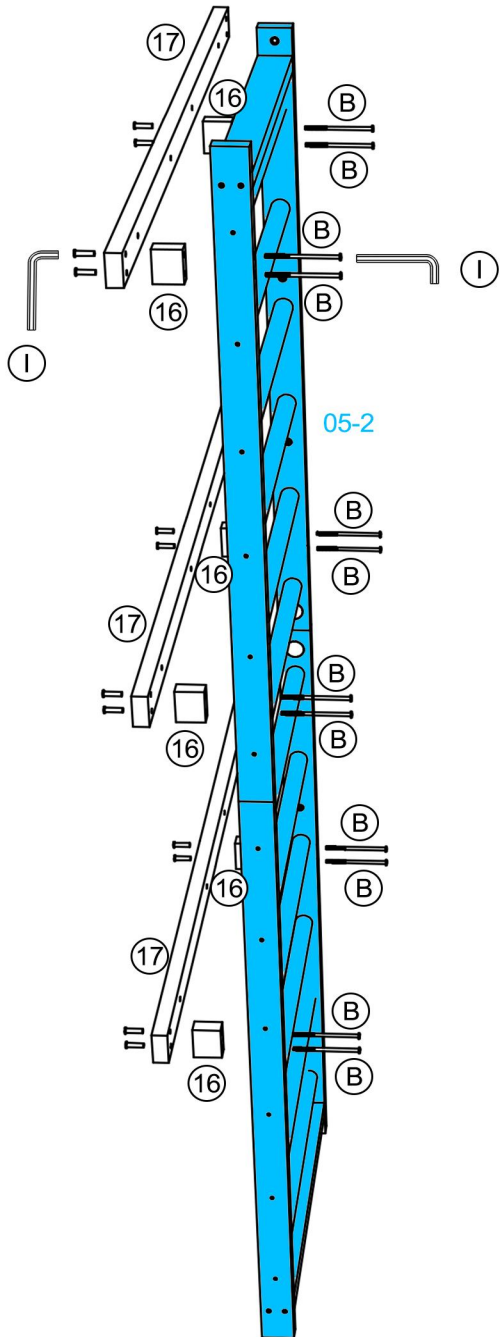

⑤		4
④		1
②		4
④		4
③		4
①		2

06-1



(B)		12
	M6x120 M6x20	
(I)		2
	M4	

06-2

Note: Pay attention to all the black bubbled section markers. The manual may refer back to those later

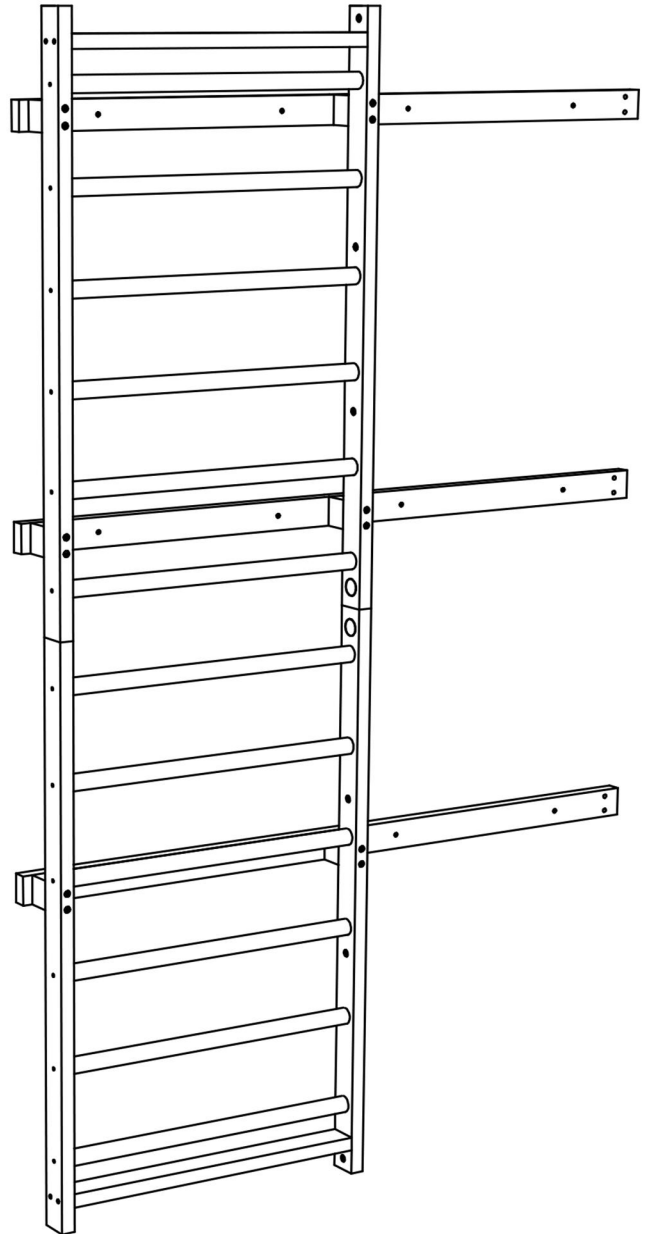

### 07-1

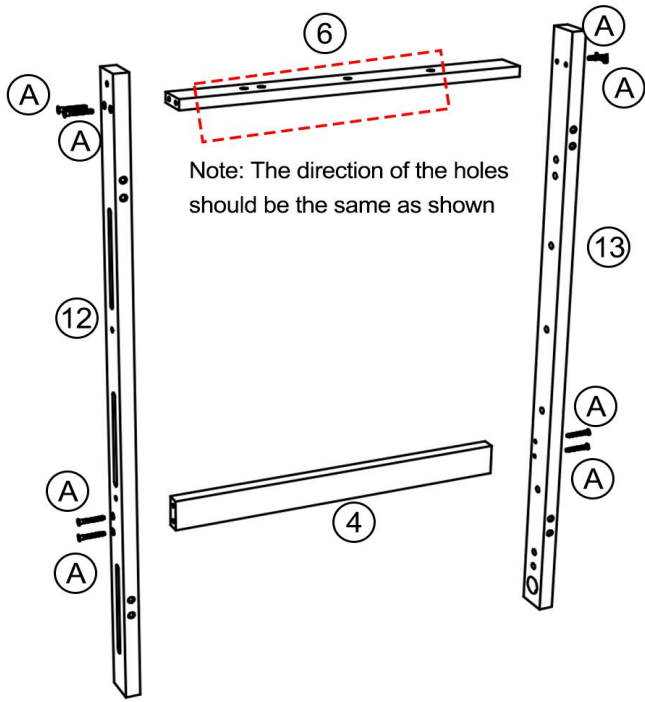

Note: The direction of the holes should be the same as shown



### 07-2

Note: Pay attention to all the black bubbled section markers. The manual may refer back to those later

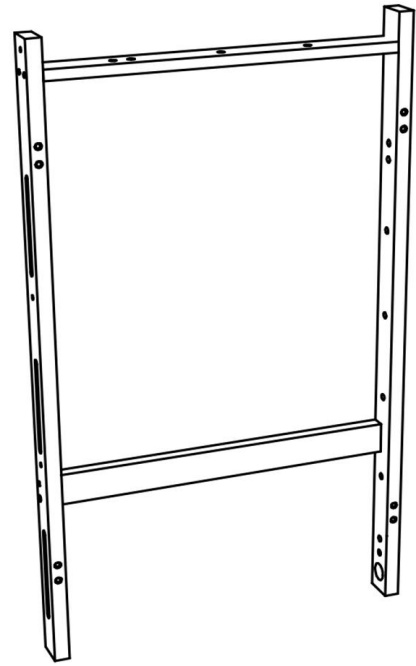

### 08-1

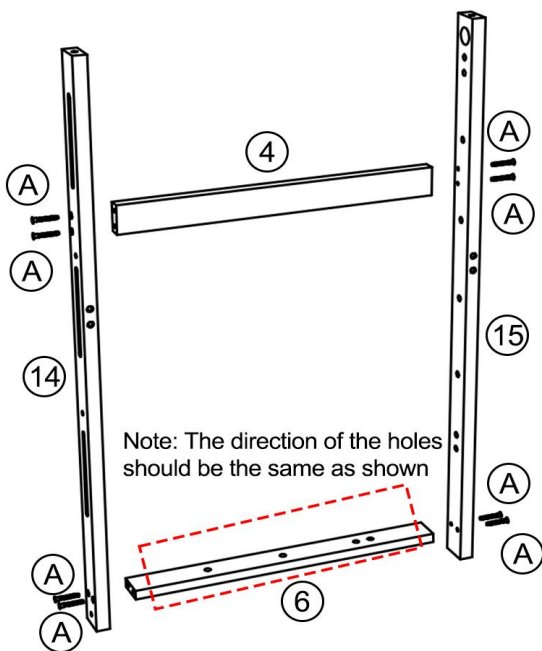

Note: The direction of the holes should be the same as shown

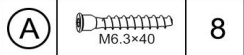

### 08-2

Note: Pay attention to all the black bubbled section markers. The manual may refer back to those later

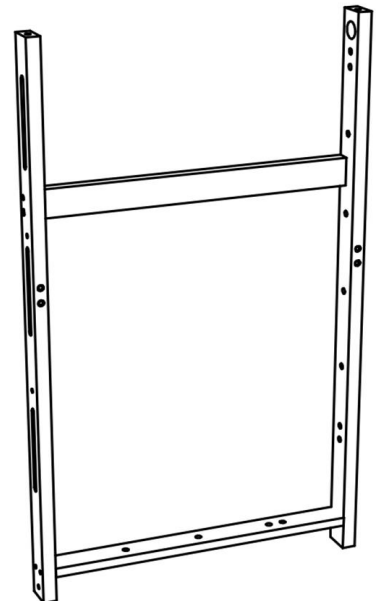



09-1

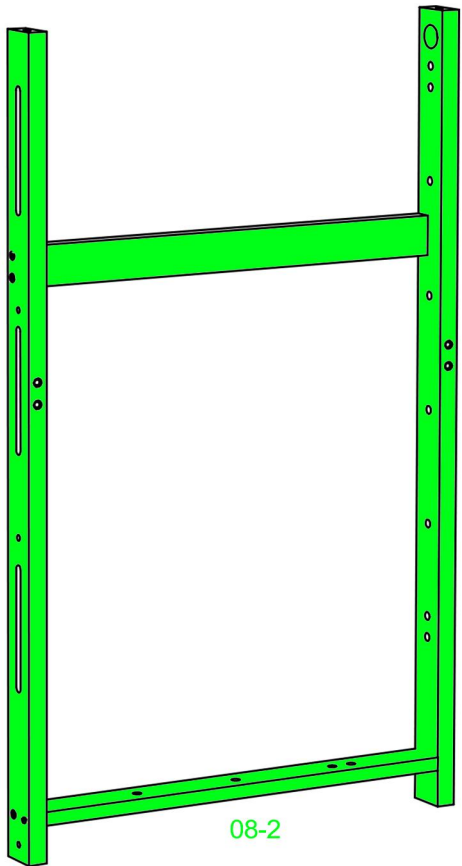
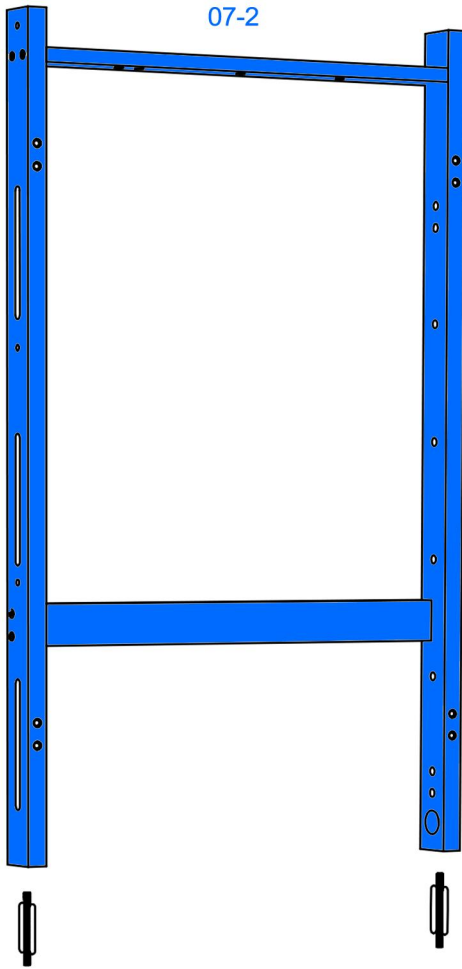

(J)	M8	1
(G)		4
(F)	M10x40	4
(E)	M8	4
(D)		4
(C)	M8x100	2

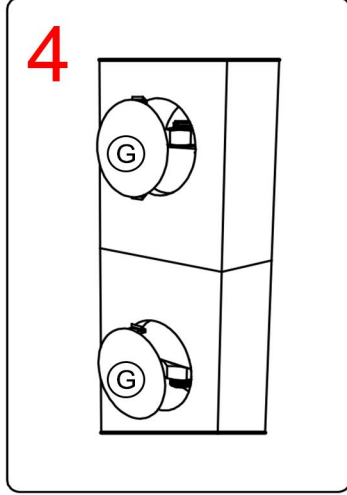
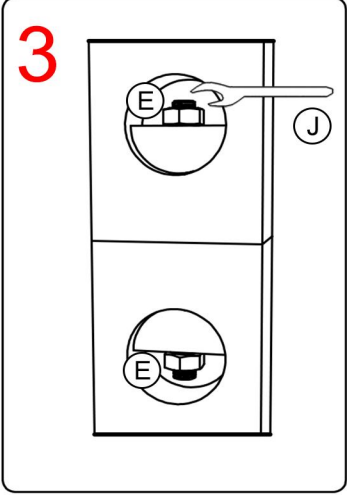
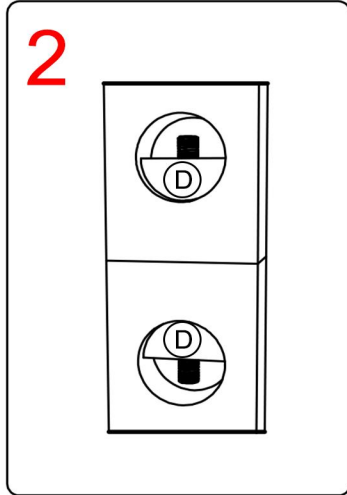
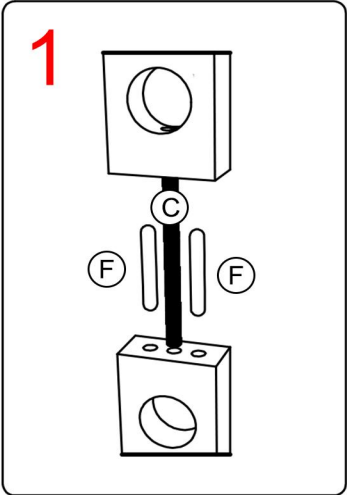

Note: Insert (C) and (F) into the holes. Attach (D), and tighten the connection by screwing on (E) to (C). Cover with (G)

09-2

Note: Pay attention to all the black bubbled section markers. The manual may refer back to those later

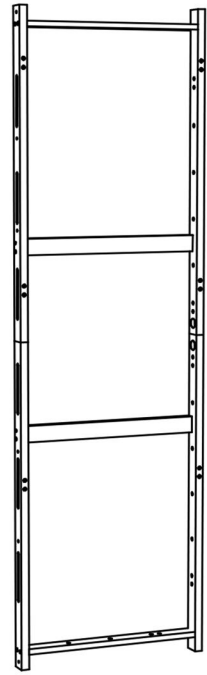

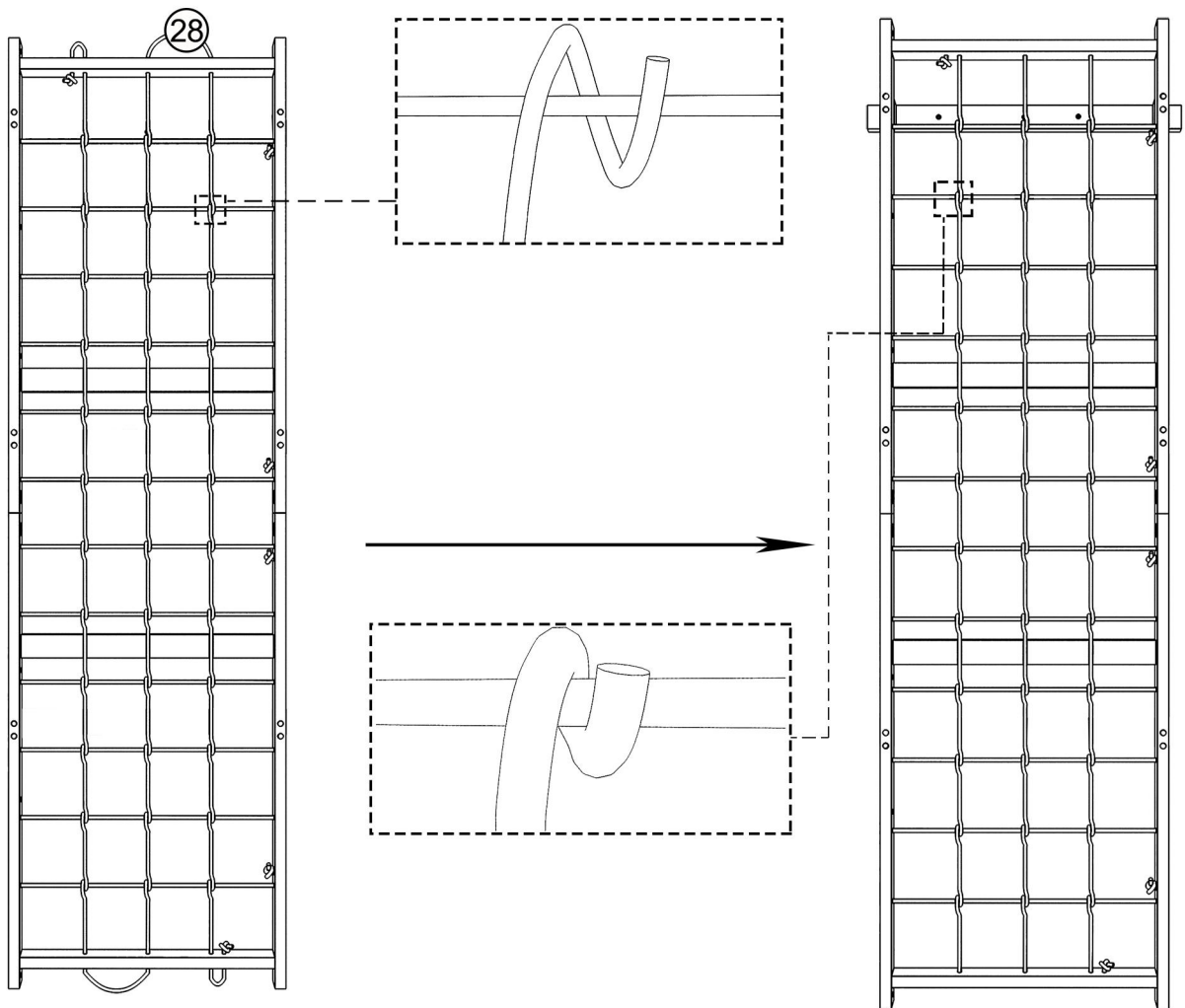
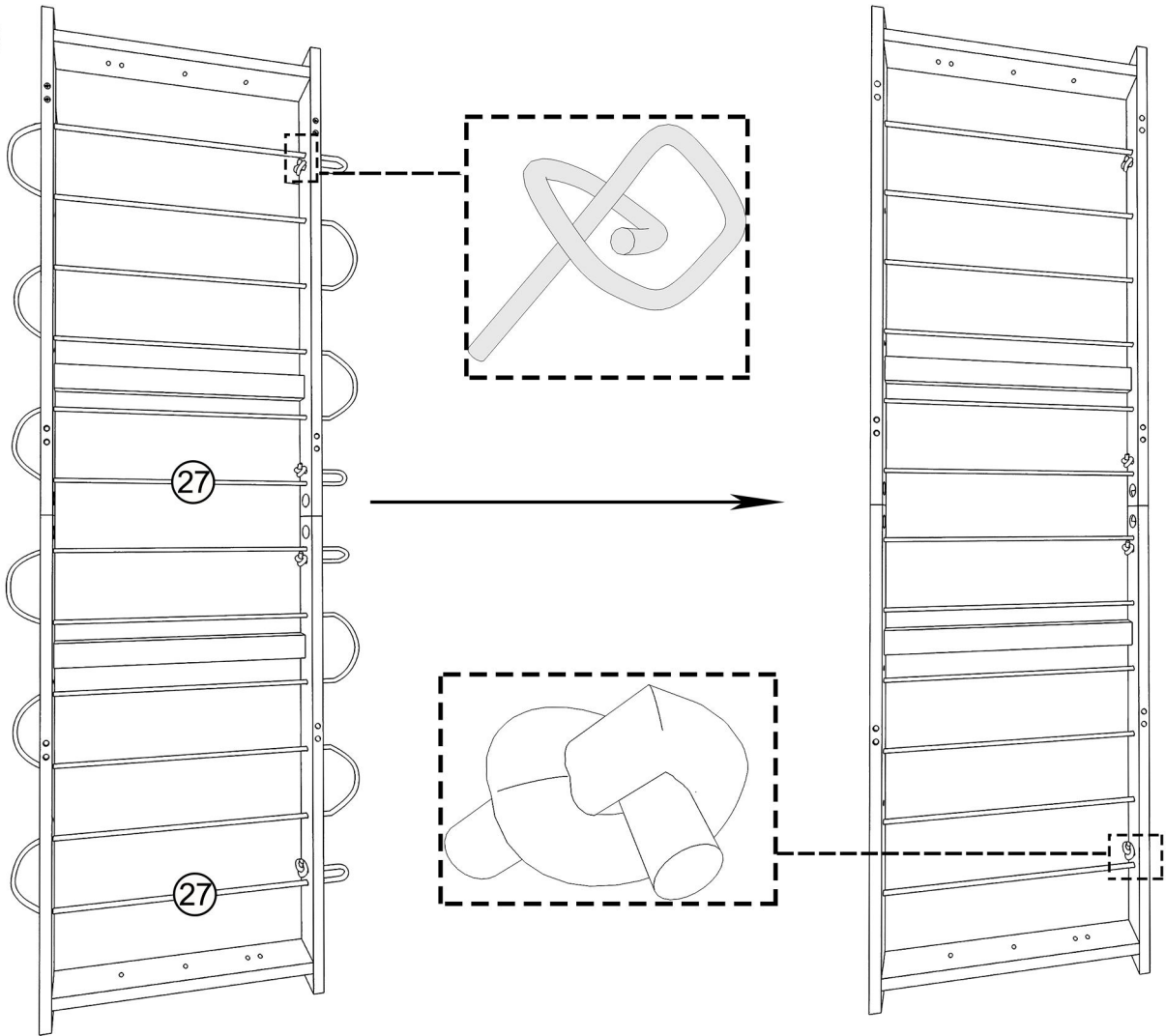

# 11-1

Note: Put the screws in the corresponding holes, don't tighten them completely, and tighten them together after the screws of part 11-2 are placed in the corresponding holes

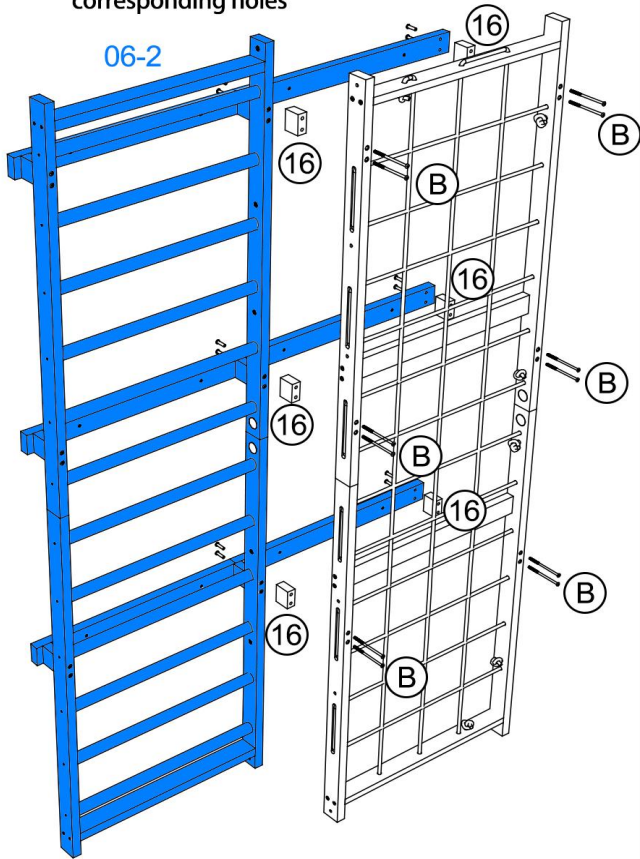

(B)		12
	M6x120 M6x20	

# 11-3

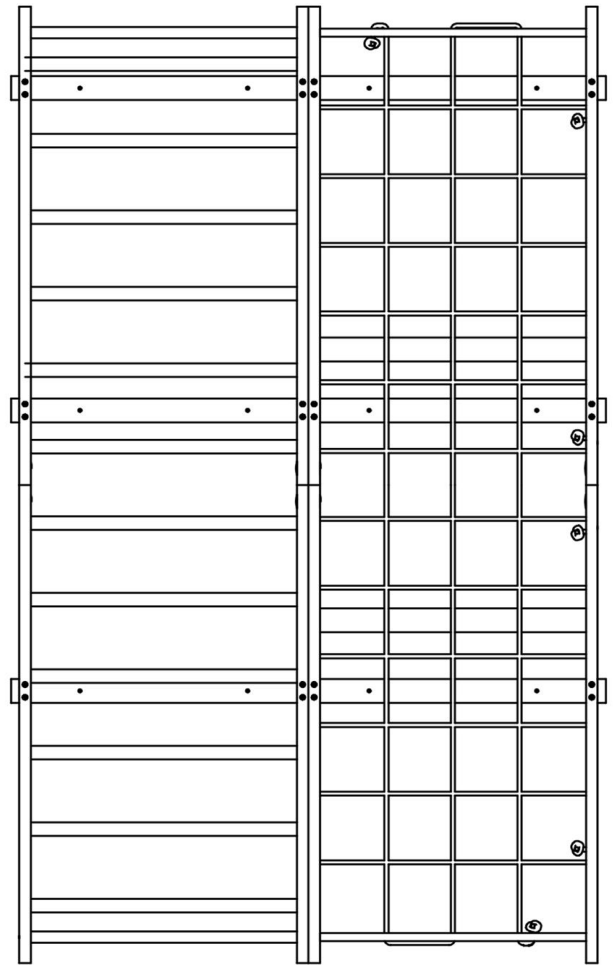

# 11-2

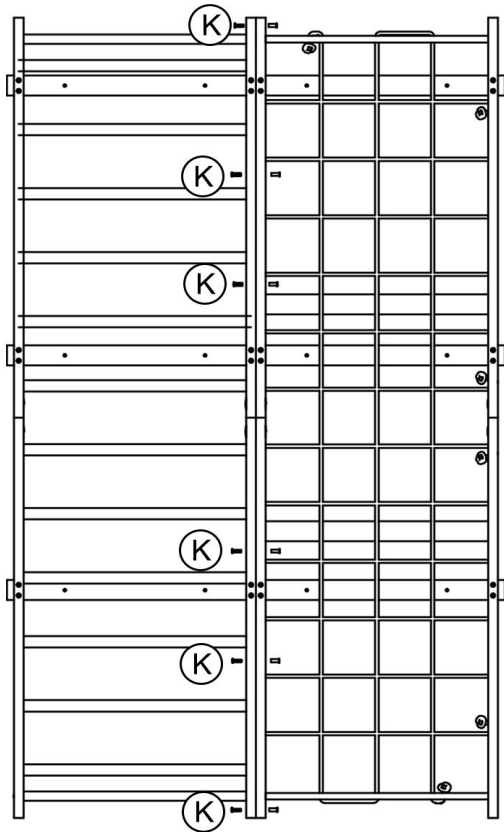

(K)		6
	M6x40 M6x20	

# 12-1

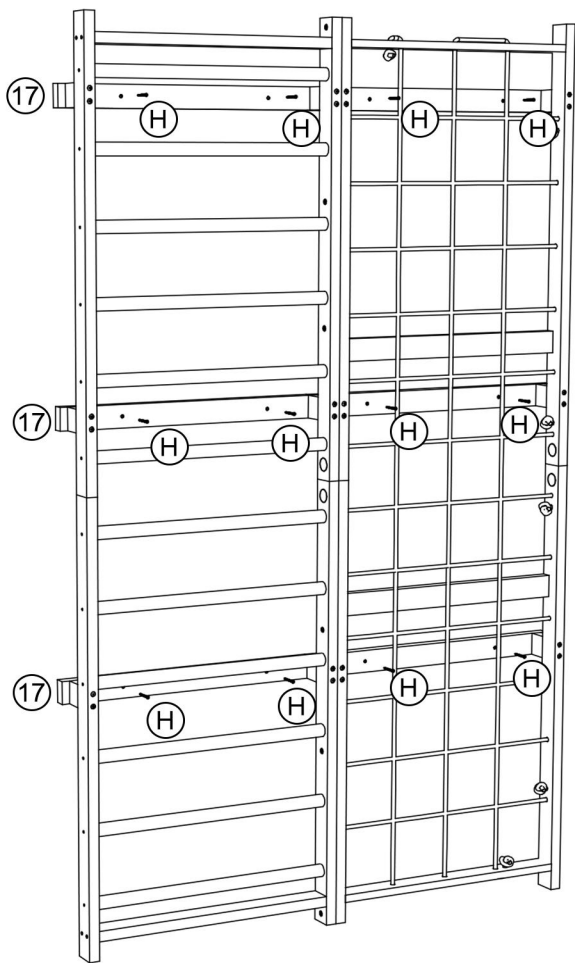

Use a studfinder and mark the wall where the center of the studs are. Studs are typically 16" apart. Measure the distance between your studs to confirm. Mark, level, and predrill holes in the wall to attach parts ①7 with screws ①H.

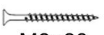
①H	 M6×80	12
----	---	----

# 12-2

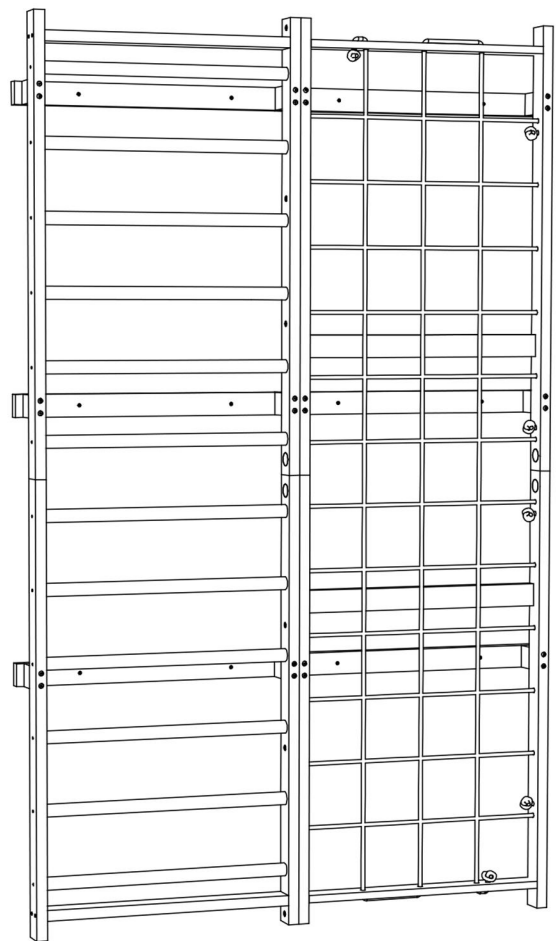

13-1

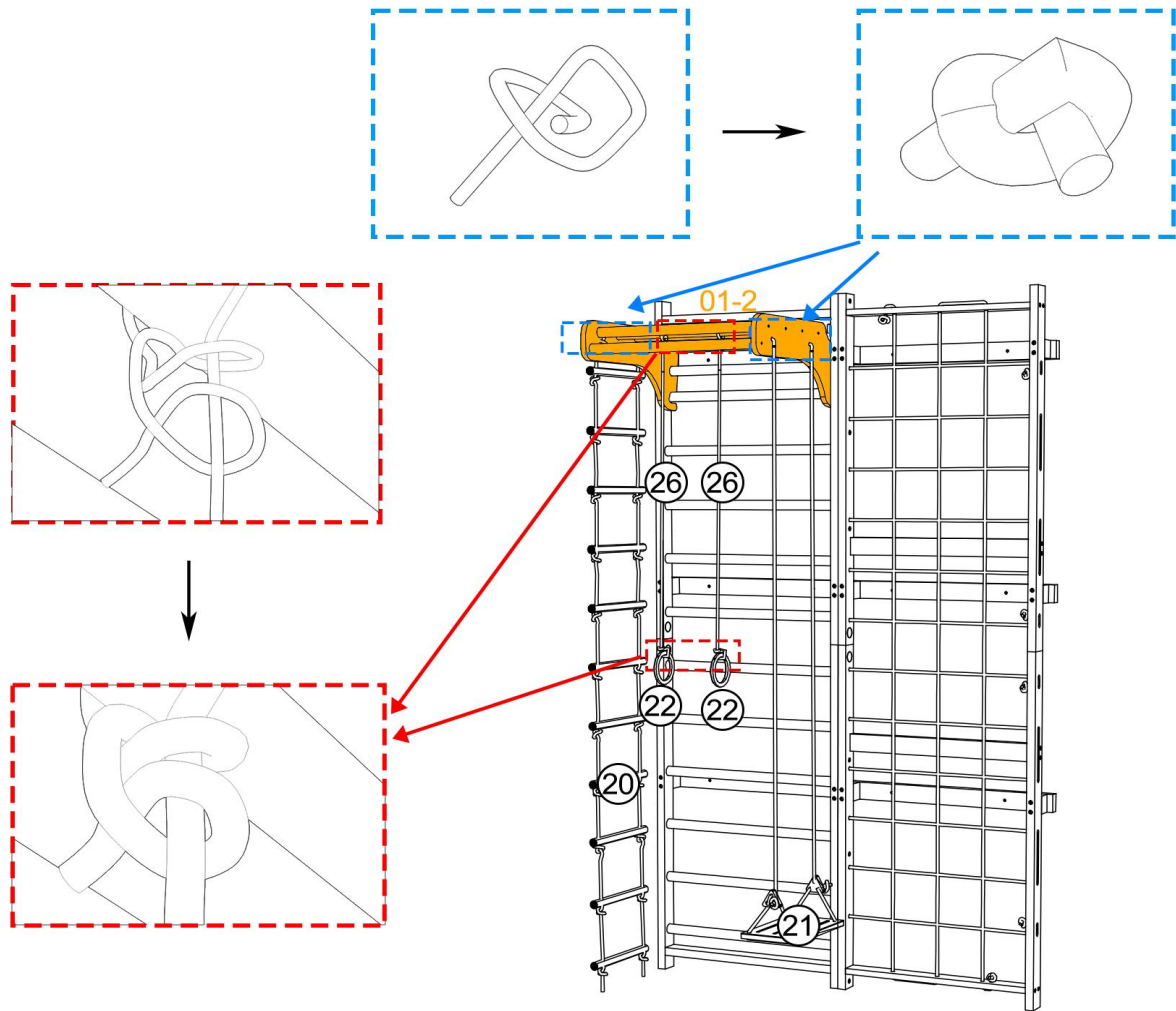

14-1

